

Dexxo Pro 800 - 1000 RTS

FR Manuel d'utilisation

DE Bedienungsanleitung

IT Manuale d'uso

NL Handleiding

EN User manual

ES Manual de utilización

PT Guia de utilização

EL Εγχειρίδιο χρήσης

TR Kullanıcı Kılavuzu

FA راهنمای استفاده

AR دليل . الاستعمال

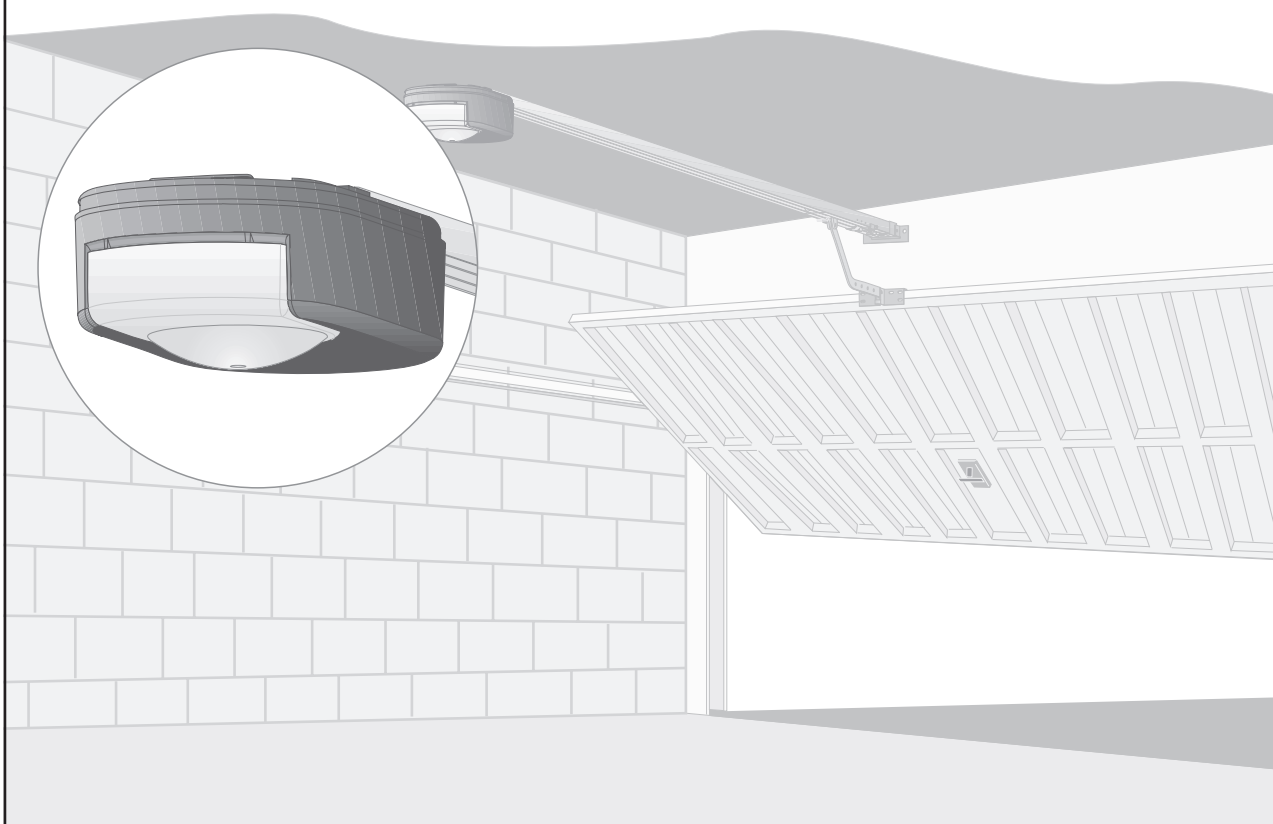

CONTENTS

GENERAL PRESENTATION	1
The world of Somfy	1
Support	1
SAFETY INSTRUCTIONS	2
Standards	2
Safety instructions	2
PRODUCT PRESENTATION	2
OPERATION AND USE	3
Normal operation	3
Special operation	4
Adding a remote control without accessing the motor head	5
TROUBLESHOOTING	5
Digital display	5
Power outage	5
PERIPHERALS	6
MAINTENANCE	6
Replacing the bulb in the light unit	6
Checking	7
Battery replacement	7
TECHNICAL SPECIFICATIONS	7

GENERAL PRESENTATION

Thank you for choosing a Somfy product. This product is designed and manufactured by Somfy in line with quality procedures that are ISO 9001 compliant.

The world of Somfy

Somfy develops, produces and sells automation systems for residential and commercial applications. Alarm systems, automatic blinds and shutters, garage doors and gates - all Somfy products are designed to fulfill your needs in terms of safety, comfort and security.

At Somfy, the quest for quality is a continual process. Somfy has built its reputation on the quality of its products and is synonymous with innovation and technological leadership worldwide.

Support

Getting to know you, listening, answering your needs, is all part of the Somfy approach.

Please contact your local Somfy retailer or installer for details on other Somfy products.

Internet: www.somfy.com

© SOMFY. SOMFY SAS, capital 20.000.000 Euros, RCS Annecy 303.970.230

SAFETY INSTRUCTIONS

Standards

This product complies with the "safety, specific rules for powering vertically opening garage doors in residential use" requirements (standard EN 60335-2-95). When installed in line with these instructions and in compliance with the "Installation Checklist", the product will be compliant with standards EN 13241-1 and EN 12453.

The instructions referred to in the Installation Manual and Instructions for Use of this product are designed to ensure that damage to property and injury to persons is avoided along with compliance with the above standards. Failure to comply with these instructions absolves Somfy from any liability for any damage that may be caused. Dexxo Pro is a product that must be installed inside the garage with a built-in back-up control system.

Somfy hereby declares that the device is compliant with the essential demands and other relevant requirements of directive 1999/5/CE. A declaration of compliance is available from the web site at www.somfy.com/ce (Dexxo Pro). This product is usable in the European Union and in Switzerland.



These are important safety instructions. For safety reasons, it is important to always follow all instructions. Retain these instructions for future reference.

Safety instructions

Every month, test that the motor drive unit reverses its motion when it encounters an obstacle that is at least 50 mm from ground level. If this is not the case, call your installation specialist. Always be very careful when using the manual release cord for a manually operated door may fall quickly due to weak or broken springs or if it is badly balanced.

Before manually operating the door or performing maintenance work, always turn the power off and where necessary remove the battery (Fig. 1).

Never let children play with door control systems. Keep the remote controls out of reach of children (Fig. 2).

When replacing the light bulb, select a 24 V 21 W BA15s type (Fig. 3).

Regularly check the operation of the door to identify any sign of wear, deterioration or incorrect balancing. Do not operate the door if repairs or adjustments are required.

Remain at a safe distance when operating the door.

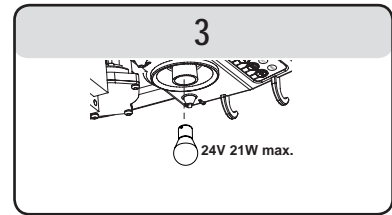
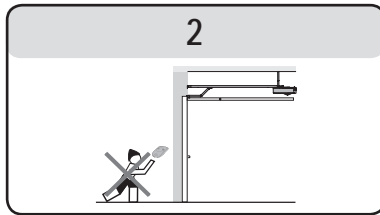
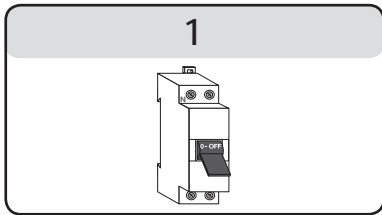

PRODUCT PRESENTATION

Description (Fig. 4)

The Dexxo Pro system is designed to power garage doors in residential use. This motor drive system comprises:

- A motor head (1) with integrated light (2) and digital operating display (5).
- A rail assembly (3) with a manual release cord (4).

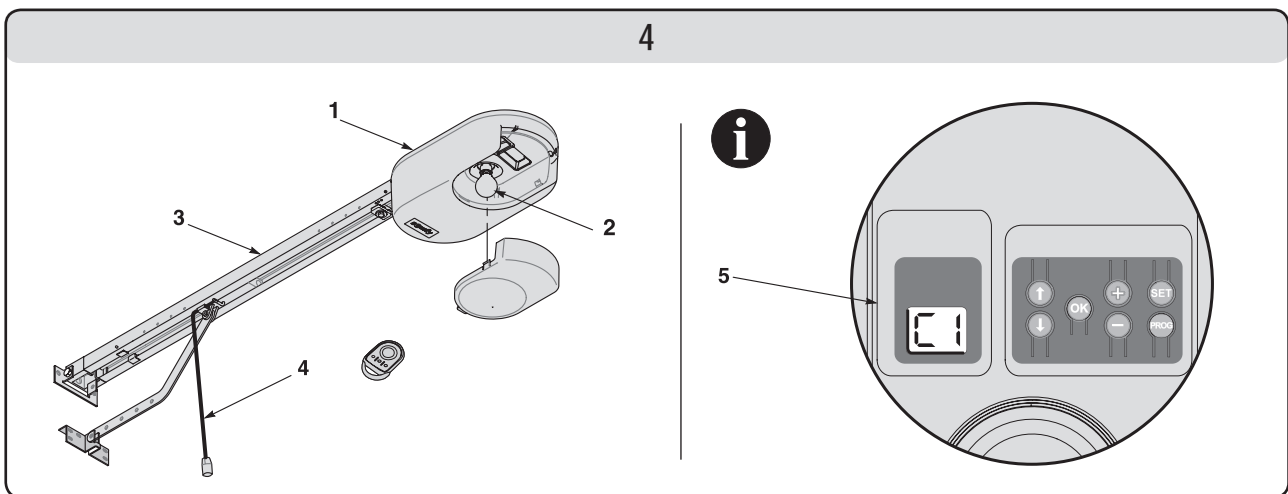

OPERATION AND USE

Normal operation

Operation in «Total opening» mode with a Keygo type remote control or similar (Fig. 5a)

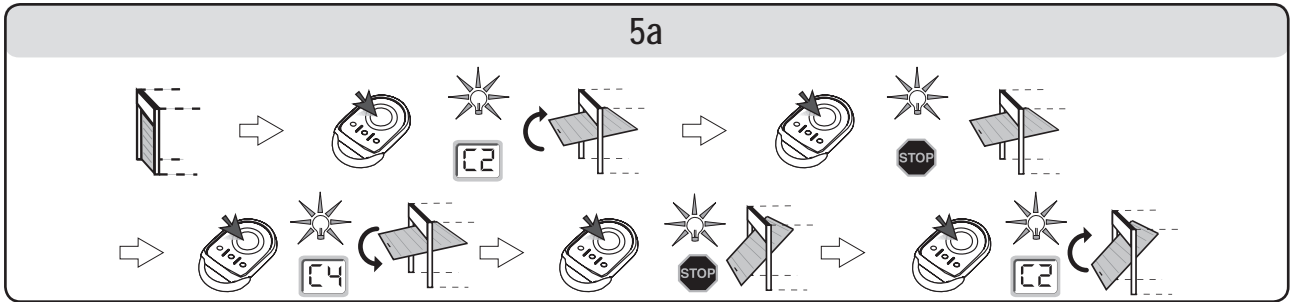

Operation in «Partial opening» mode with a Keygo type remote control or similar (Fig. 5b)

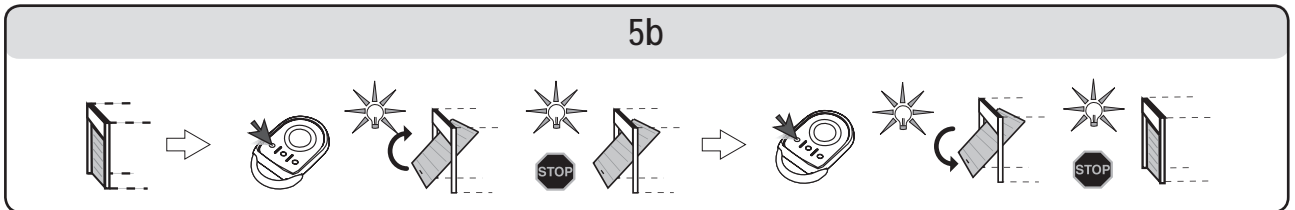

Obstacle detection operation (Fig. 6 and 7)

When an obstacle is detected during the open cycle, the door will stop (Fig. 6).

When an obstacle is detected during the close cycle, the door will stop and then reopen (Fig. 7).

Once an obstacle has been detected, the light will flash for 30 seconds.

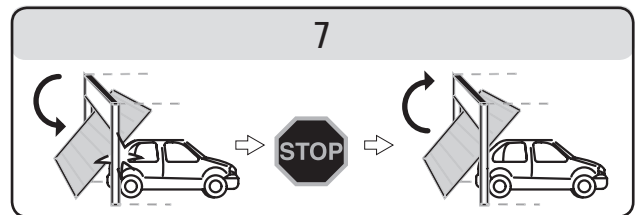
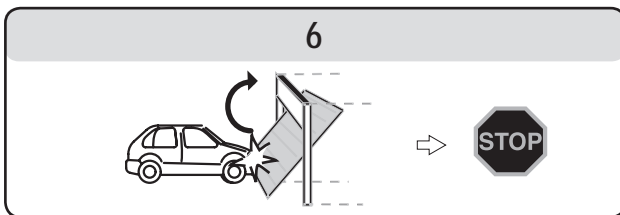

Light operation

The light will come on each time the motor drive unit is operated. The light will go out one minute after the door stops moving.

Repetitive use that causes the light to be continually on may result in a thermal cut out (this will automatically turn the light off).

Manual release cord operation (Fig. 8)

Dexxo Pro is fitted with a manual release mechanism so that you can move the door manually should a power failure occur, for example. The manual release mechanism should be easily accessible and located no more than 1.80 metres above floor level.

- [1]. Disengaging the motor drive mechanism
Pull on the manual release cord until the door drive mechanism is disengaged.
- [2]. Manually moving the door
This is possible as long as the door drive mechanism is disengaged.
- [3]. Reengaging the motor drive mechanism
Move the door manually until the drive mechanism comes to reengage itself into the transmission rail.

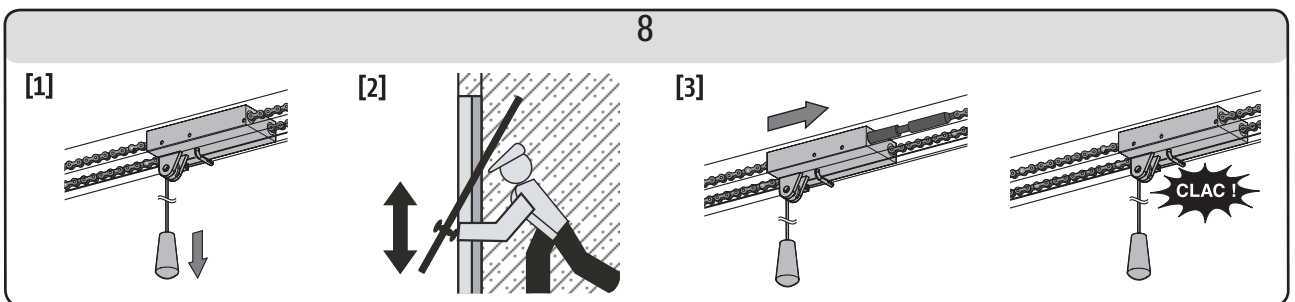

When disengaging the motor drive mechanism, use caution for a badly balanced door may cause sudden door movement that may be dangerous.

Only use the cord to disengage the motor drive mechanism. Never use the cord to move the door manually. Always reengage the motor drive mechanism before sending another command to the motor drive unit.

Special operation

Depending on the peripherals installed and the operating options set by your installer, the Dexxo Pro system may perform the following special operations:

Operation in «Total opening» mode with a Telis type remote control or similar (Fig. 9a)

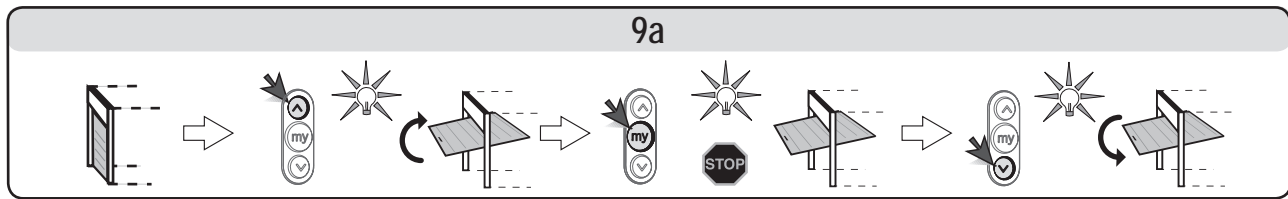

Operation in «Partial opening» mode with a Telis type remote control or similar (Fig. 9b)

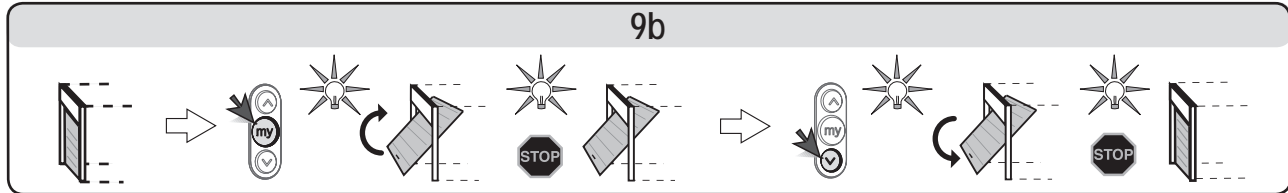

Safety photoelectric cell operation

An obstacle detected between the cells will prevent the door from closing.

The door will stop and then completely or partially reopen (depending on the setup selected during installation) when an obstacle is detected during the close cycle.

The light will flash for 30 seconds during this process.

Pedestrian door safety function

Opening a pedestrian door within the garage door will prevent the door from moving.

The light will flash for 30 seconds during this process.

Flashing orange light

The orange warning light will flash every time the door moves.

A two second delay before the door starts to move can be selected during installation.

Remote lighting operation

The light comes on every time the motor drive unit is operated. The light will go out one minute after the door stops moving. The time delay can be adjusted during installation.

If a remote control button is programmed for remote lighting, it works as illustrated in Fig. 10.

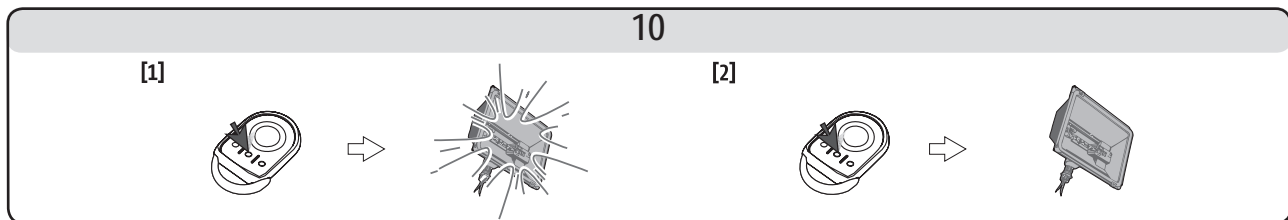

Automatic closure mode operation

The door is automatically closed after a time delay set at the time of installation.

An additional command during this time will cancel the automatic closure and the door will remain open.

The next command will close the door.

Working from the back-up battery

If a back-up battery is installed, the Dexxo Pro motor will operate when a power cut occurs.

The following conditions apply to operation:

- Door speed is reduced.
- The light will not come on.
- The safety devices are disabled.

Battery specifications:

- Endurance: The battery will last for 24 hours with a maximum of 5 to 10 operating cycles depending on the weight of the door.
- Recharging time: 48 hours.
- Service life prior to replacement: approx. three years.

To ensure optimum battery life, we recommend that the power to the motor is switched off and the door is operated for a number of cycles using battery power (three times a year).

Forced operation mode (Fig. 11)

This function is used to move the door at any time (remote control lost, safety mechanism failure, etc.).

Remove the built-in lighting cover:

- Control door motion using the "+" and "-" buttons.
- Pressing and holding the "-" button will trigger closure.
- Pressing and holding the "+" button will trigger opening.

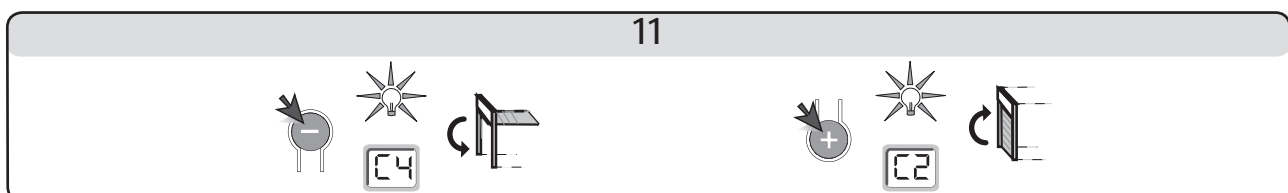

Detection of forced entry operation

Detection of forced entry starts operating 30 seconds after the door is closed.

If forced entry is detected, the siren will sound for 2 minutes, the light integrated in the motor and the orange light (if installed) will flash. To stop the siren, press a button on a memorised remote control.

Adding a remote control without accessing the motor head

With a Keygo (Fig.12a)

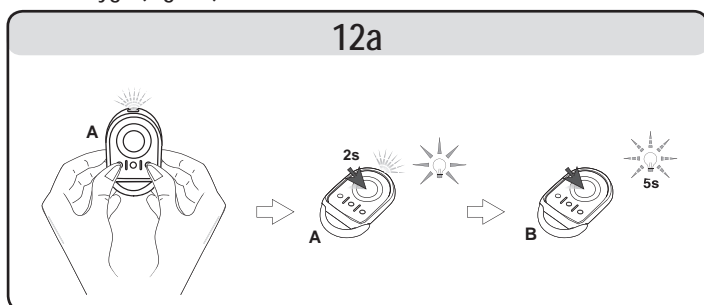

With a Telis or similar (Fig.12b)

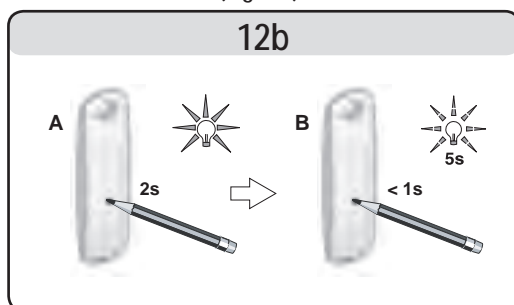

TROUBLESHOOTING

Digital display

The LCD display is situated under the lighting cover. It provides motor operation status.

The main operating codes are as follows:

Code	Description	Comments
C1	Waiting for a command	
C2	Door opening	
C3	Waiting for the door to close	
C4	Door closing	
C5	Obstacle detection	Indicates that the door encountered an obstacle. The display is maintained for 30 s after detection.
C6	Safety input active	Indicates that an obstacle preventing door closure is present between the photoelectric cells or is in contact with the safety sensor bar installed on the door.
C9	Pedestrian door safety contact active	Indicates that the pedestrian door within the garage door is open. Door operation is inhibited.
Cb	Permanent hardwired control	Indicates that the hardwired control input is permanently active. Commands from radio remote control units are inhibited.
CC	Maintenance is required	Indicates that maintenance is required on the installation. Contact your installer.
Cd	Working from back-up battery Waiting for a command	Indicates that the main power supply to the motor is cut and that the motor is powered by the battery back-up pack.
H1	Detection of forced entry	Indicates that an attempt to open the garage door has been made from outside. Press a button on the memorised remote control to stop the siren. Start a complete opening and closing cycle.
H2	Detection of forced entry	Indicates that an attempt to open the garage door has been made from outside. Press a button on the memorised remote control to stop the siren. Start a complete opening and closing cycle.

If other codes are displayed, contact your Somfy installer.

Power outage

Following a power outage, the motor must recognise its «fully open» position again.

Open the door fully using a memorised remote control. The door will open at a degraded speed.



Allow the door to open to the "fully open" position.

PERIPHERALS

A number of peripherals are available.

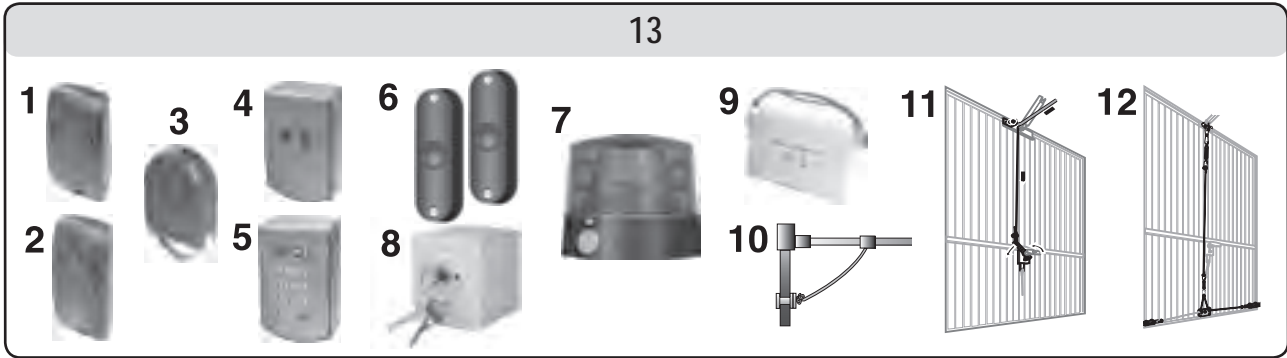

Key	Description	Comments
1	Keytis 2NS RTS remote control	Hand held 2 channel remote control.
2	Keytis 4NS RTS remote control	Hand held 4 channel remote control.
3	Keygo remote control	Four channel keyring remote control.
4	RTS pushbutton	Wall mounted 2 channel remote control switch.
5	RTS radio code keypad	Access code control point. For use outside the garage.
6	Photoelectric cells	To prevent door closure if an obstacle is detected.
7	Orange light	To signal a warning when the door operates.
8	Keyswitch	Keyswitch for secure control.
9	Battery	To provide continued operation during a power cut.
10	Release lock	To engage the manual release system from the outside using the existing door handle. Highly recommended when the garage door is the only access point into the garage.
11	Outside release lock	To engage the manual release system from the outside using the existing door handle. Highly recommended when the garage door is the only access point into the garage.
12	Door locking kit	A system to reinforce door locking.

MAINTENANCE

Replacing the bulb in the light unit (Fig. 14)

[1] [2]. Remove the light cover.

[3] [4]. Unscrew and replace the defective light bulb.

[5] [6] [7]. Refit the light cover.

Use a 24 V 21 W BA15s socket light bulb.

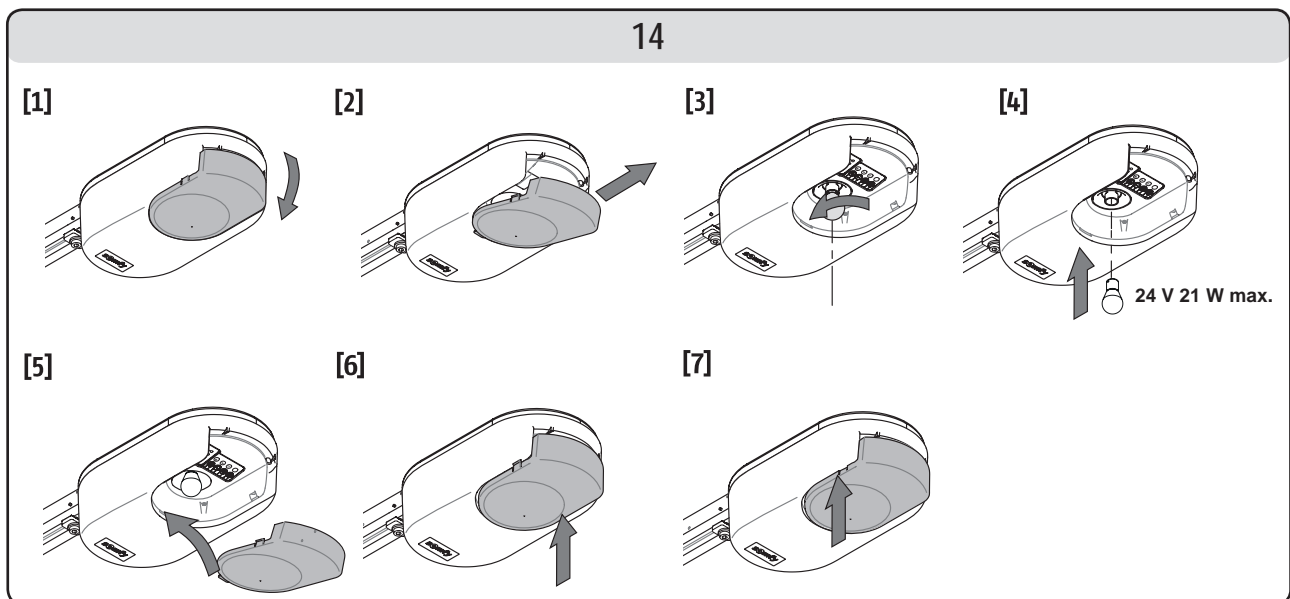

Checking

The obstacle detection function

Every six months, check that the door reverses direction when an obstacle prevents the door from closing (at least 50 mm above floor level).

The safety mechanisms (cells, pedestrian door contact, sensor bar)

Check correct operation every six months (refer to page 4).

The back-up battery

To ensure optimum battery life, we recommend that the power to the motor is switched off and the door is operated for a number of cycles using battery power (three times a year).

Battery replacement

Keytis

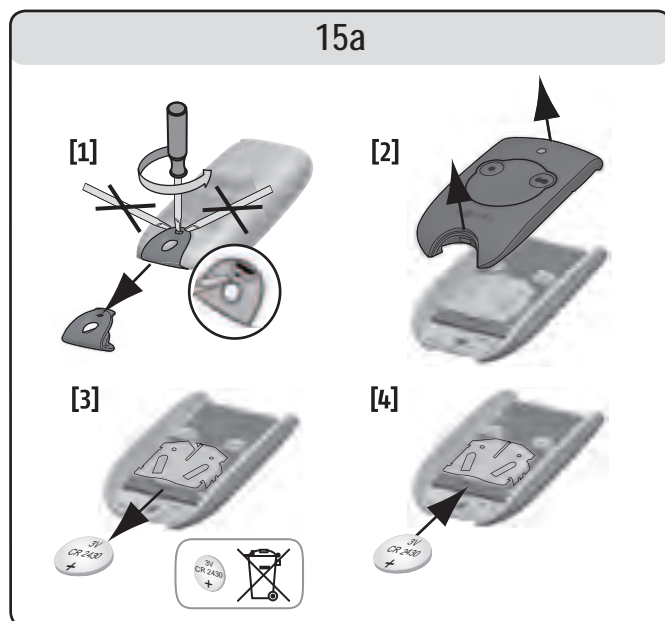

Keygo

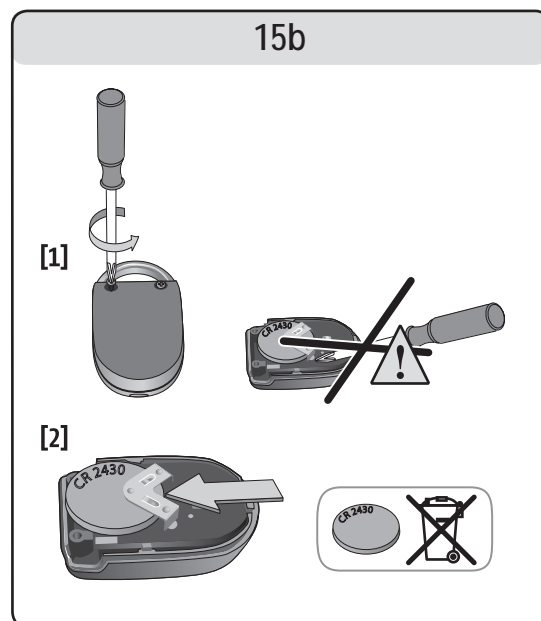

RECYCLING



Do not dispose of your scrapped appliances, nor your used batteries with household waste. You are liable to dispose of all your electronic or electrical equipment waste by relocating over to a dedicated collection point for recycling.

TECHNICAL SPECIFICATIONS

Basic technical specifications	Dexxo Pro 800	Dexxo Pro 1000
Mains power supply	230 V - 50 Hz	
Power consumption on standby	5 W	
Max. power consumption	600 W (with 500 W remote controlled lighting)	
Traction force – Peak force	800 N	1000 N
Use	20 cycles per day with a standard rail (tested for 36,500 cycles) 50 cycles per day with a high performance rail (tested for 90,000 cycles)	
Number of channels that can be memorised	32	
Somfy radio frequency	433.42 MHz RTS	
Integrated light	24 V / 21 W max. BA15s socket	
Remote controlled lighting	230 V / 500 W max. Class 2 <input type="checkbox"/>	
Operating temperature	-20 °C / +60 °C	

**Listes des filiales / Somfy weltweit / Elenco delle filiali / Lijst van filialen
Lists of subsidiaries / Lista de filiales / Lista das filiali / Λίστες θυγατρικών**

قائمة الفروع / فهرست نمایندگیها / Bağlı şirketler

Argentina : Somfy Argentina
+55 11 (0) 4737-37000

Australia : Somfy PTY LTD
+61 (0) 2 9638 0744

Austria : Somfy GesmbH
+43(0) 662 / 62 53 08 - 0

Belgium : Somfy Belux
+32 (0)2 712 07 70

Brasil : Somfy Brasil STDA
+55 11 (0) 6161 6613

Canada : Somfy ULC
+1 (0) 905 564 6446

China : Somfy China Co. Ltd
+8621 (0) 6280 9660

Cyprus : Somfy Middle East
+357 (0) 25 34 55 40

Czech Republic : Somfy Spol s.r.o.
(+420) 296 372 486-7

Denmark : Somfy Nordic AB Denmark
+45 65 32 57 93

Finland : Somfy Nordic AB Finland
+358 (0) 957 13 02 30

France : Somfy France
+33 (0) 820 374 374

Germany : Somfy GmbH
+49 (0) 7472 9300

Greece : Somfy Hellas
+30 210 614 67 68

Hong Kong : Somfy Co. Ltd
+852 (0) 2523 6339

Hungary : Somfy Kft
+36 1814 5120

India : Somfy India PVT Ltd
+91 (0) 11 51 65 91 76

Indonesia : Somfy IndonesiaEra
+62 (0) 21 719 3620

Iran : Somfy Iran
0098-217-7951036

Israel : Sisa Home Automation Ltd
+972 (0) 3 952 55 54

Italy : Somfy Italia s.r.l
+39-024 84 71 84

Japan : Somfy KK
+81 (0)45-475-0732
+81 (0)45-475-0922

Jordan : Somfy Jordan
+962-6-5821615

**Kingdom of Saudi Arabia :
Somfy Saoudi**
Riyadh : +966 1 47 23 203
Jeddah : +966 2 69 83 353

Kuwait : Somfy Kuwait
00965 4348906

Lebanon : Somfy Middle East
+961(0) 1 391 224

Malaysia : Somfy Malaysia
+60 (0) 3 228 74743

Mexico : Somfy Mexico SA de CV
+52(0) 55 5576 3421

Morocco : Somfy Maroc
+212-22951153

Netherlands : Somfy BV
+31 (0) 23 55 44 900

Norway : Somfy Norway
+47 67 97 85 05

Poland : Somfy SP Z.O.O
+48 (0) 22 509 53 00

Portugal : Somfy Portugal
+351 229 396 840

Romania : Somfy SRL
+40 - (0)368 - 444 081

Russia : Somfy LLC
+7 095 781 47 72

Singapore : Somfy PTE LTD
+65 (0) 638 33 855

Slovak Republic : Somfy Spol s.r.o.
(+421) 33 77 18 638

South Korea : Somfy JOO
+82 (0) 2 594 4333

Spain : Somfy Espana SA
+34 (0) 934 800 900

Sweden : Somfy Nordic AB
+46 (0) 40 165900

Switzerland : Somfy A.G.
+41 (0) 44 838 40 30

Syria : Somfy Syria
+963-9-55580700

Taiwan : Somfy Taiwan
+886 (0) 2 8509 8934

Thailand : Somfy Thailand
+66 (0) 2714 3170

Turkey : Somfy Turkey
+90 (0) 216 651 30 15

United Arab Emirates : Somfy Gulf
+971 (0) 4 88 32 808

United Kingdom : Somfy LTD
+44 (0) 113 391 3030

United States : Somfy Systems Inc
+1 (0) 609 395 1300

