

# Volet application

Semi-ajouré



Ajouré











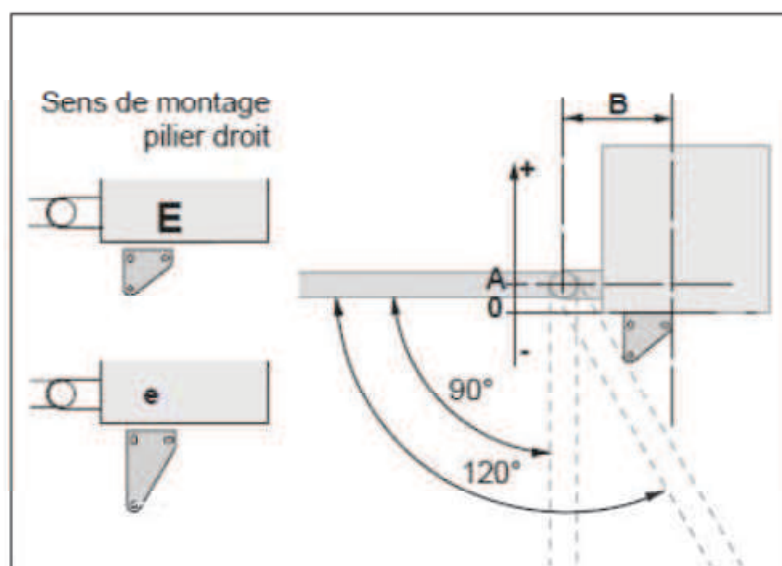



















Plein



A (mm)	B (mm)	angle max (°)	Position patte
-30	325	110	e
-30	315	115	e
0	310	110	e
0 à 10	305	100	e
10 à 20	305	110	e
20 à 30	295	105	e
30 à 40	295	105	e
40 à 50	285	100	e
50 à 60	275	100	e
60 à 70	300	110	E
70 à 90	290	105	E
90 à 110	280	100	E
110 à 120	270	100	E
120 à 130	260	95	E
130 à 150	250	90	E
150 à 160	240	90	E
160 à 170	230	90	E
170 à 180	220	85	E
180 à 190	215	85	E
190 à 200	205	80	E

Côtes déconseillées pour vantaux > 2 mètres



Effets du vent suivant les types de portail	Caractéristiques Max des produits					
Force du vent	Effets	Poids / Lg vantail				
≥ à 80Km/h	On ne marche plus contre le vent		 Lg max : 1.50m Poids max : 200Kg	 Lg max : 1.50m Poids max : 200Kg	 Lg max : 1.50m Poids max : 250Kg	 Lg max : 1.50m Poids max : 250Kg
< à 80Km/h > à 40 Km/h	Les branches des arbres s'agitent		 Lg max : 1.80m Poids max : 200Kg  Lg max : 1.50m Poids max : 200Kg	 Lg max : 2.50m Poids max : 200Kg  Lg max : 1.50m Poids max : 200Kg	 Lg max : 2.50m Poids max : 250Kg  Lg max : 1.50m Poids max : 250Kg	 Lg max : 2.50m Poids max : 250Kg  Lg max : 1.50m Poids max : 250Kg
≤ à 40 Km/h	Le sable s'envole		 Lg max : 1.80m Poids max : 200Kg  Lg max : 1.80m Poids max : 200Kg  Lg max : 1.80m Poids max : 200Kg	 Lg max : 2.50m Poids max : 200Kg  Lg max : 2.50m Poids max : 200Kg  Lg max : 2.50m Poids max : 200Kg	 Lg max : 2.50m Poids max : 250Kg  Lg max : 2.50m Poids max : 250Kg  Lg max : 2.50m Poids max : 250Kg	 Lg max : 2.50m Poids max : 250Kg  Lg max : 2.50m Poids max : 250Kg  Lg max : 2.50m Poids max : 250Kg